

**MUNICIPIO DE MAZATLAN**  
 CALLE ANGEL FLORES S/N COLONIA CENTRO MAZATLAN, SIN.

PRESIDENTE MUNICIPAL  
 LIC. EDGAR AUGUSTO GONZÁLEZ ZATARAIN

DIRECTOR DE OBRAS PUBLICAS  
 ING. RIGOBERTO ARÁMBURO BOJÓRQUEZ

SUBDIRECTOR DE OBRAS PUBLICAS:  
 ING. MARTIN GALLARDO NORIEGA

JEFE DEL DEPTO. DE PROYECTO Y TOPOGRAFIA:  
 ING. JUAN CARLOS GALARZA BARRON

INTEGRANTES DEL DEPARTAMENTO DE PROYECTOS:  
 ING. CARLOS MANUEL TAPIA BARRON  
 ARQ. ANA GABRIELA OSUNA  
 ARQ. JESUS IVAN MORENO JIMENEZ

PROYECTO:  
 TECHUMBRE METALICA DE 12.60X19.60MTS  
 JARDIN DE NIÑOS JUSTO SIERRA  
 EN SAN FRANCISQUITO

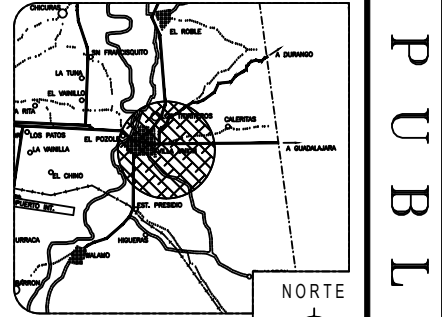

LOCALIZACION

ESCALA: S/E	LAMINA No. 7
FECHA: MARZO DEL 2023	CLAVE
DISEÑO - DIBUJO: ARQ. ANA GABRIELA OSUNA RENDÓN	

OBRAS PUBLICAS

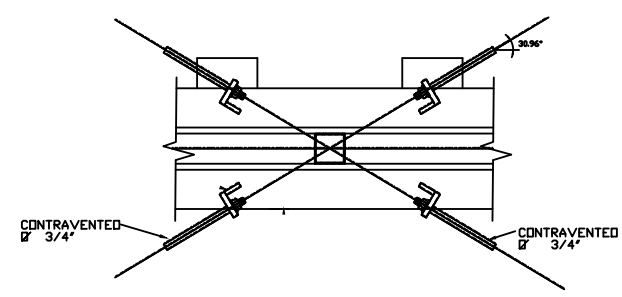

contraventeo

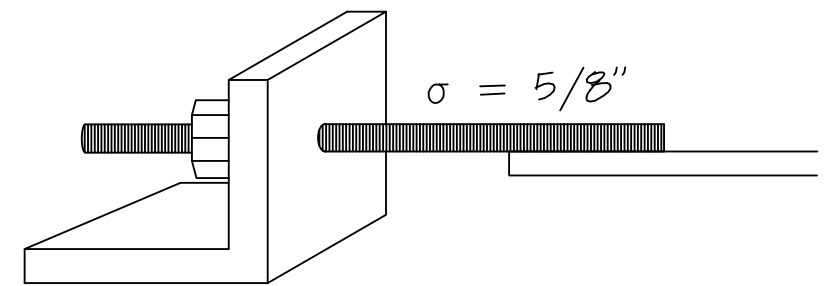

CLICK DE ANGULO 3" X 3" X 3/16" PESO=5.52 KG/ML  
 DETALLE DE CONTRAFLAMBEOS  
 con acero pl 5/8"  
 montaje, primer pintura a dos manos

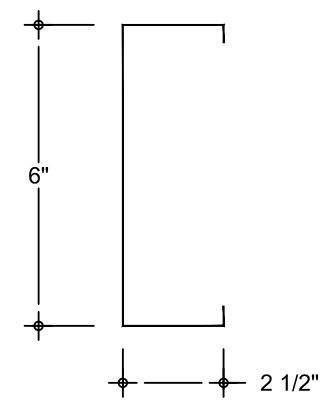

LARGUEROS  
 PESO=4.46 KG/ML

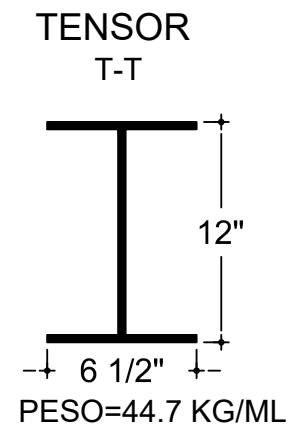
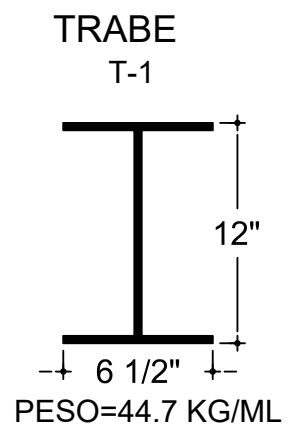
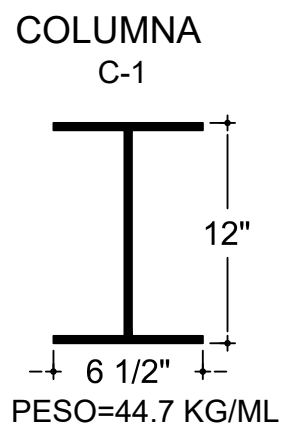

RELLENO SOLDADURA

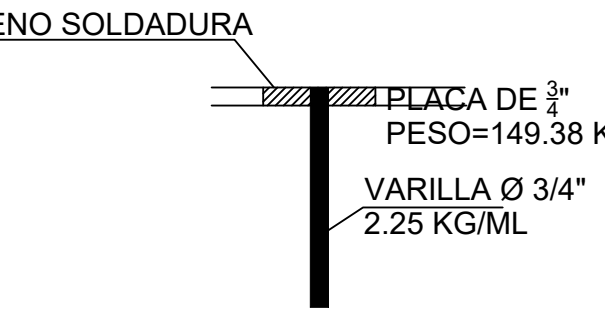

DETALLE DE VARILLAS  
 SOLDADAS A PLACA BASE

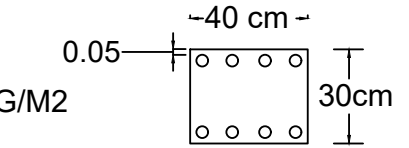

NOTA: SE SOLDARA  
 VARILLAS DE DADO A PLACA BASE

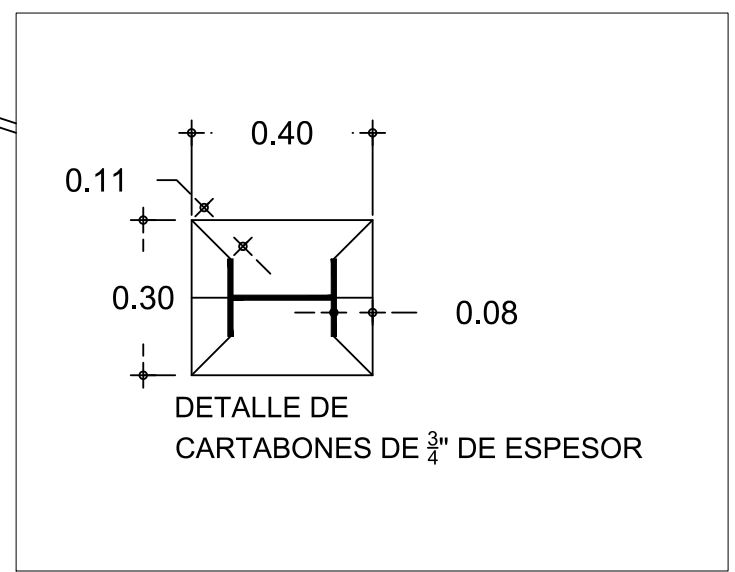
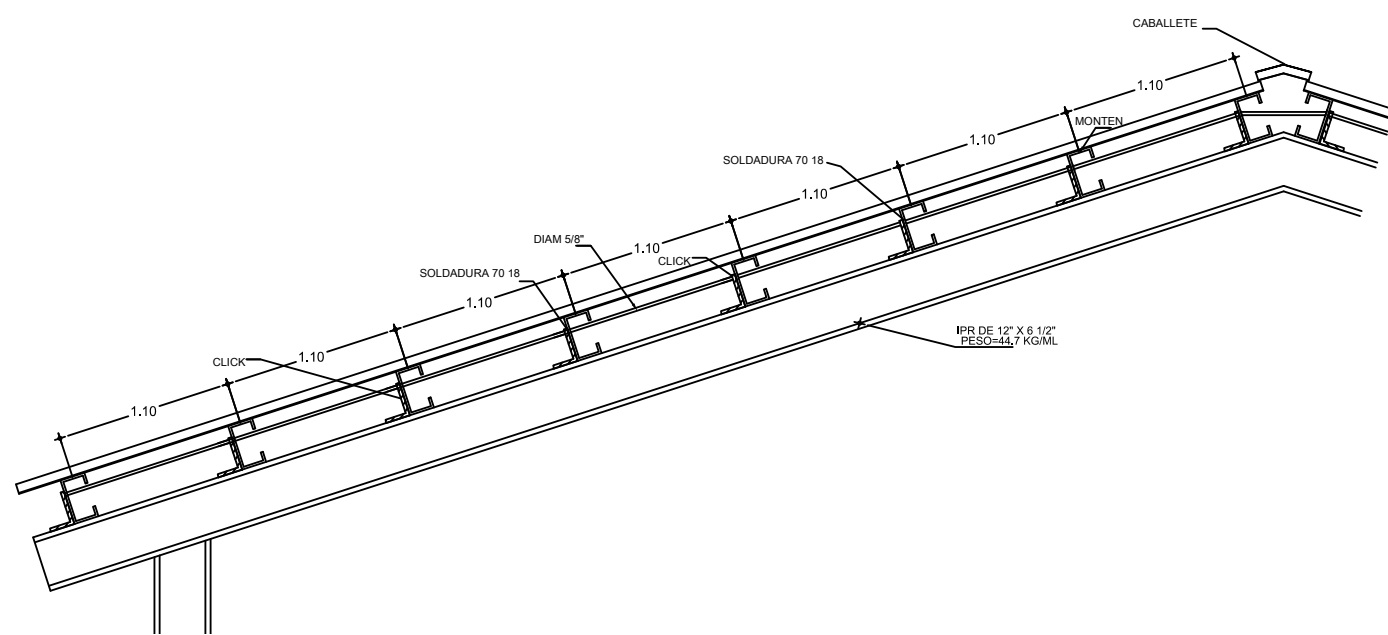

DETALLE DE  
 CARTABONES DE 3/4" DE ESPESOR