



- Simbología
- ÁREA EXISTENTE SOLO FALTA UN TRAMO DE LAMINA GALVANIZADA
 - CONSTRUCCIÓN ETAPA 2022 UN ENTRE EJE Y UN TRAMO DE LAMINA GALVANIZADA
 - ETAPA A FUTURO

Obra: **AMPLIACIÓN DE TECHUMBRE METÁLICA DE TALLER MECÁNICO EN P.E.P.**

Localidad: Culiacán Municipio de: Culiacán

Contenido: **PLANO CONSTRUCTIVO**

Dibujo: M.G.I.L.

Escala: INDICADAS

Fecha: 03/01/2022 Plano: 01

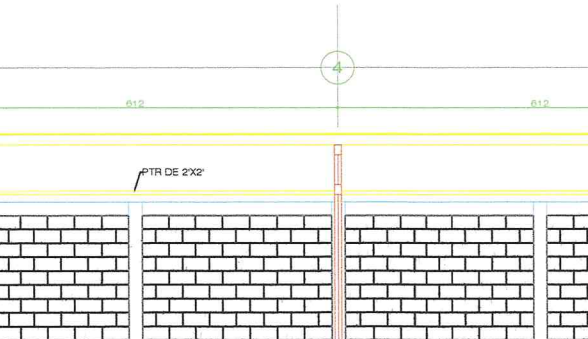
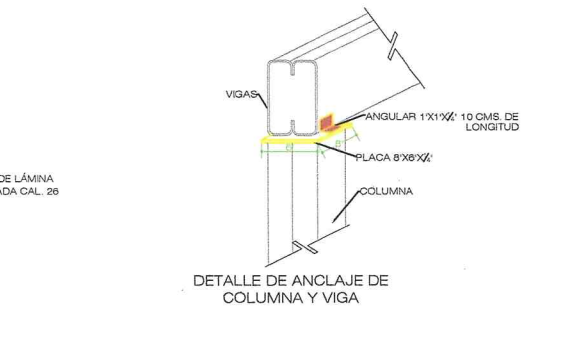
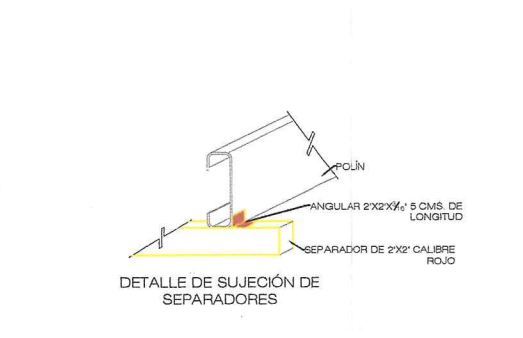
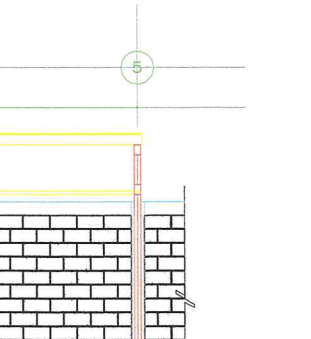
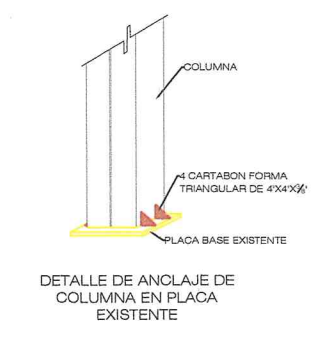
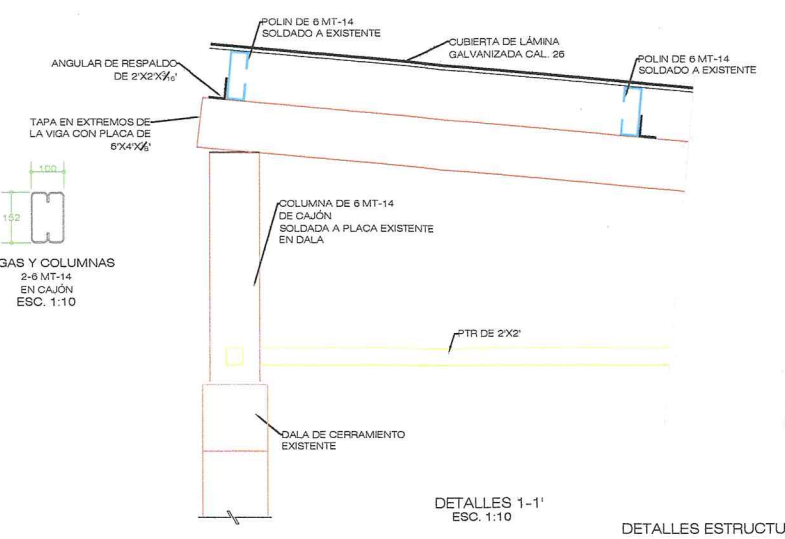
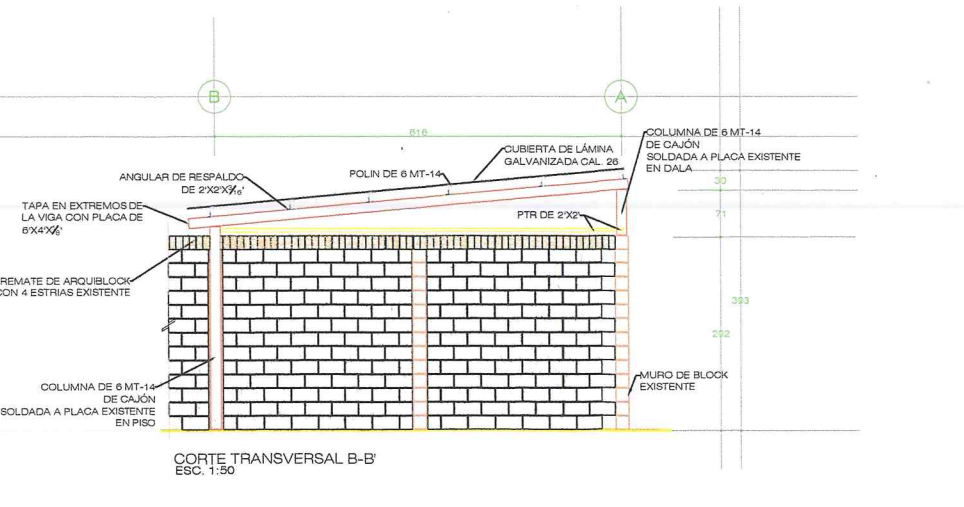
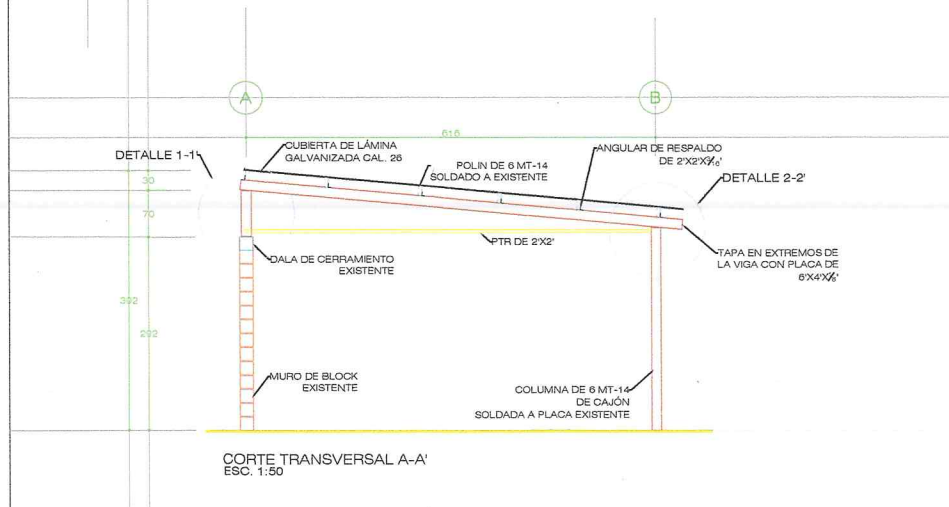
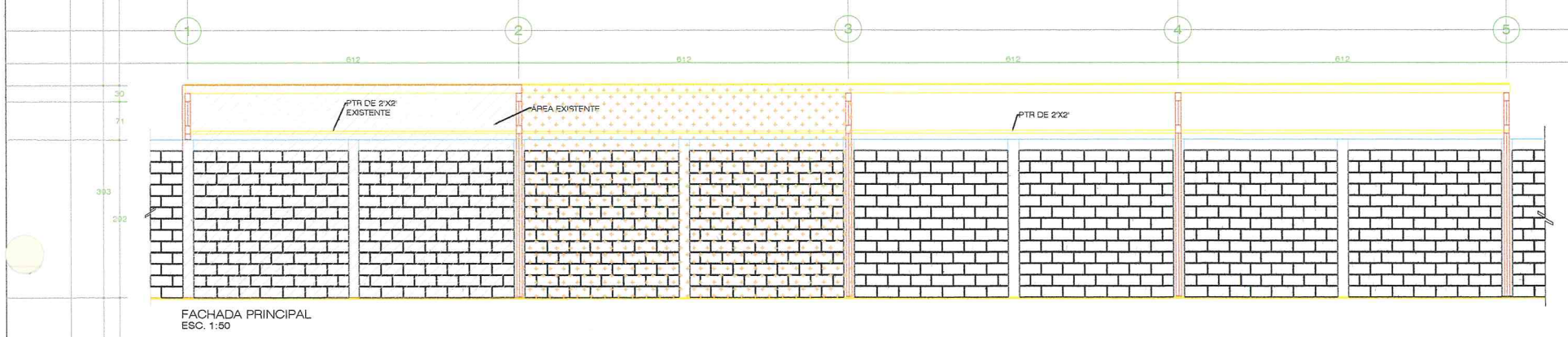
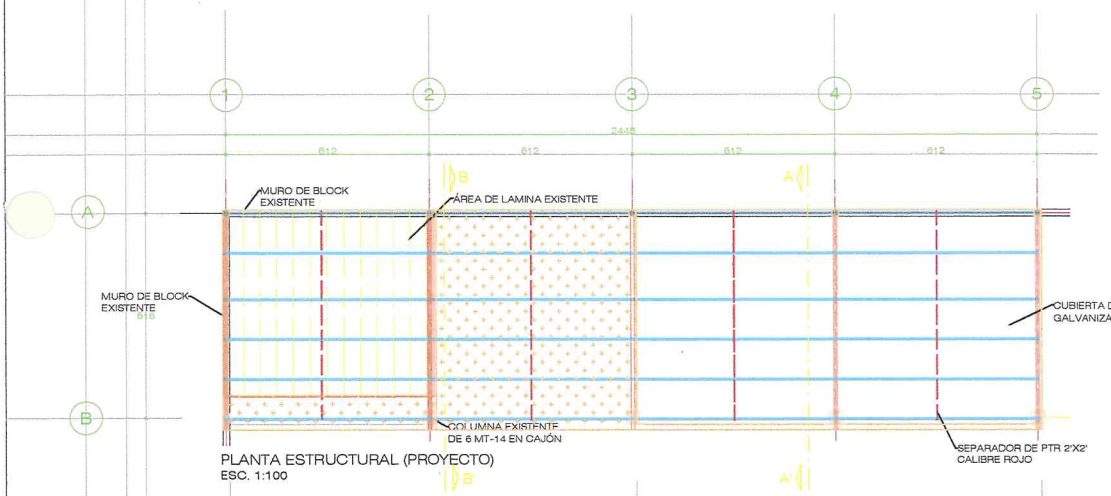
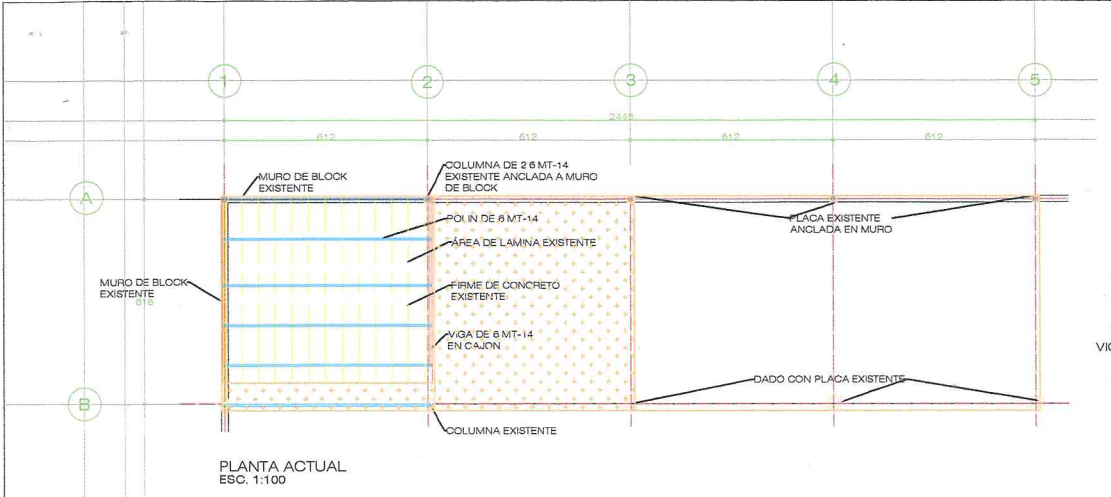



Arq. José Manuel Acosta Bernal
Director de Estudios y Proyectos

Arq. Ruby Valdez Lizárraga
Jefe de Departamento de Proyectos de Edificación



Simbología

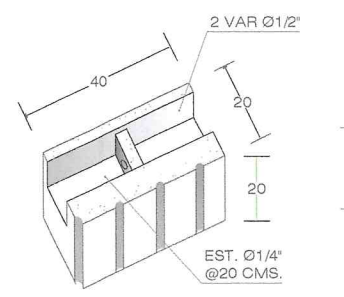
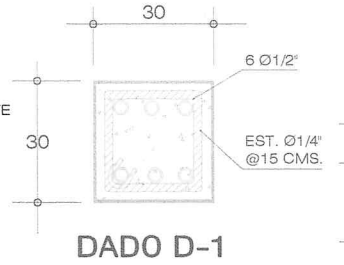
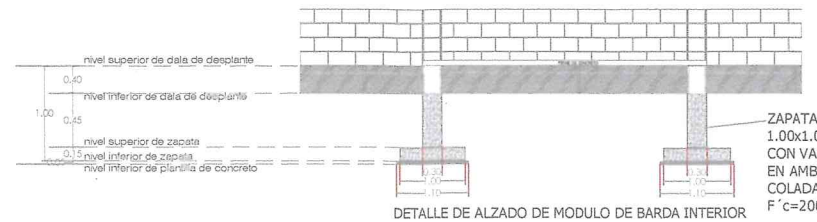
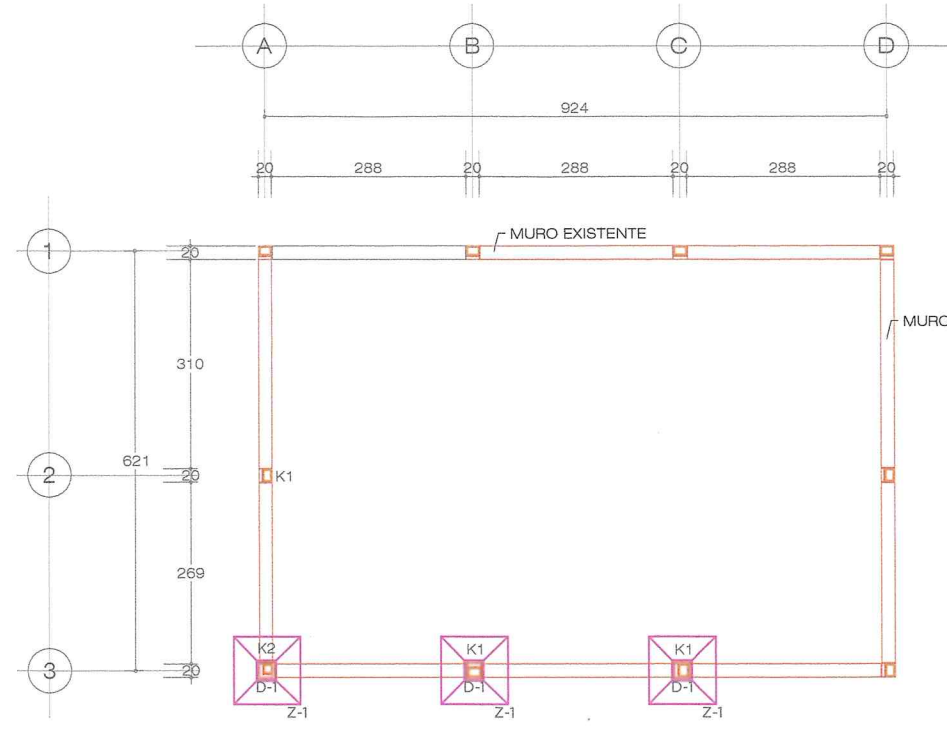

ARQUÍBLOCK CUATRO ESTRIAS ISOMÉTRICO
DALA DE CERRAMIENTO TIPO "U" 20X20X40CM. CON 4 ESTRIAS

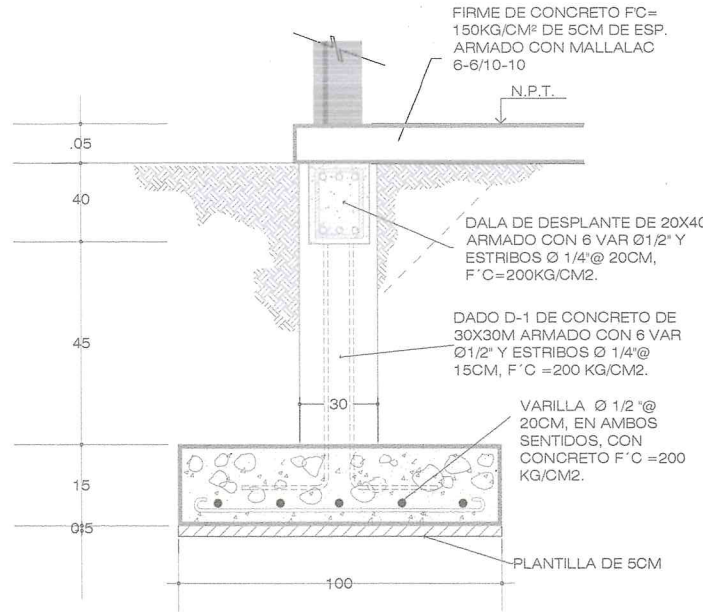

ZAPATA Z-1

CASTILLO K1 20X15 BLOCK 20X20X40

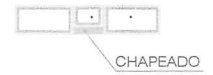

DETALLE DE CASTILLO

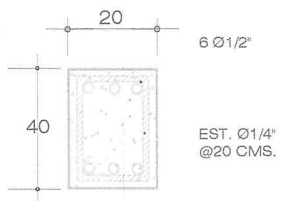

DALA DE DESPLANTE

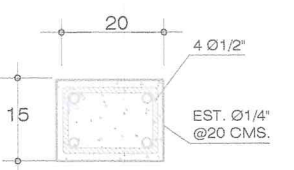

CASTILLO K-1

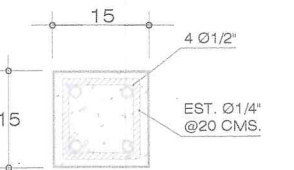

CASTILLO K-2

SIMBOLOGIA

- LAMPARAS
- ⊗ APAGADOR DOBLE DE 15 AMP. 127V, MODELO MODUS COLOR MARFIL MARCA BTICINO.

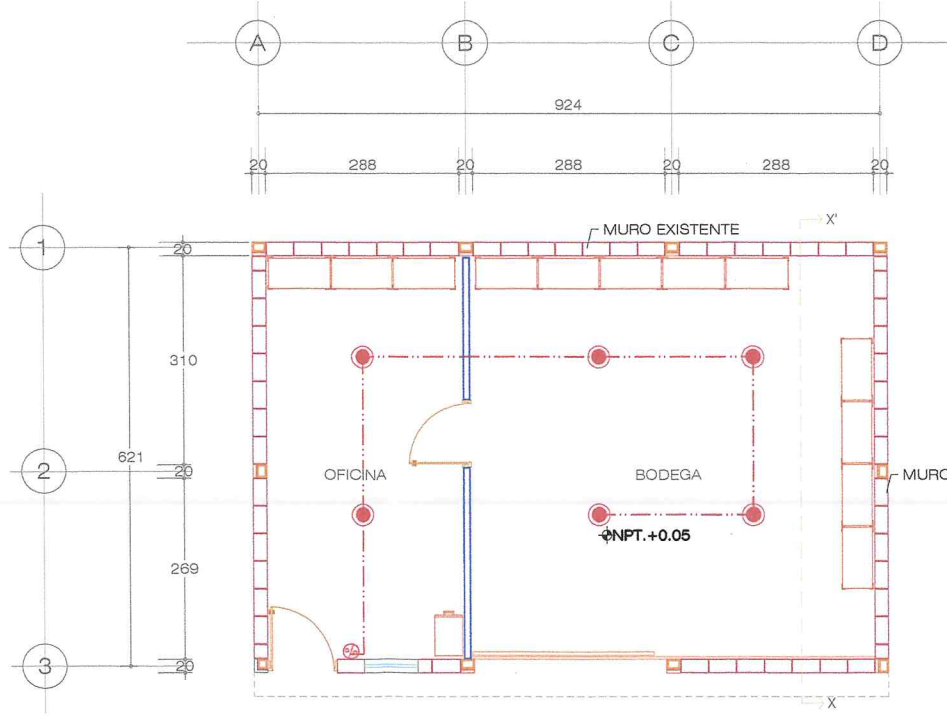
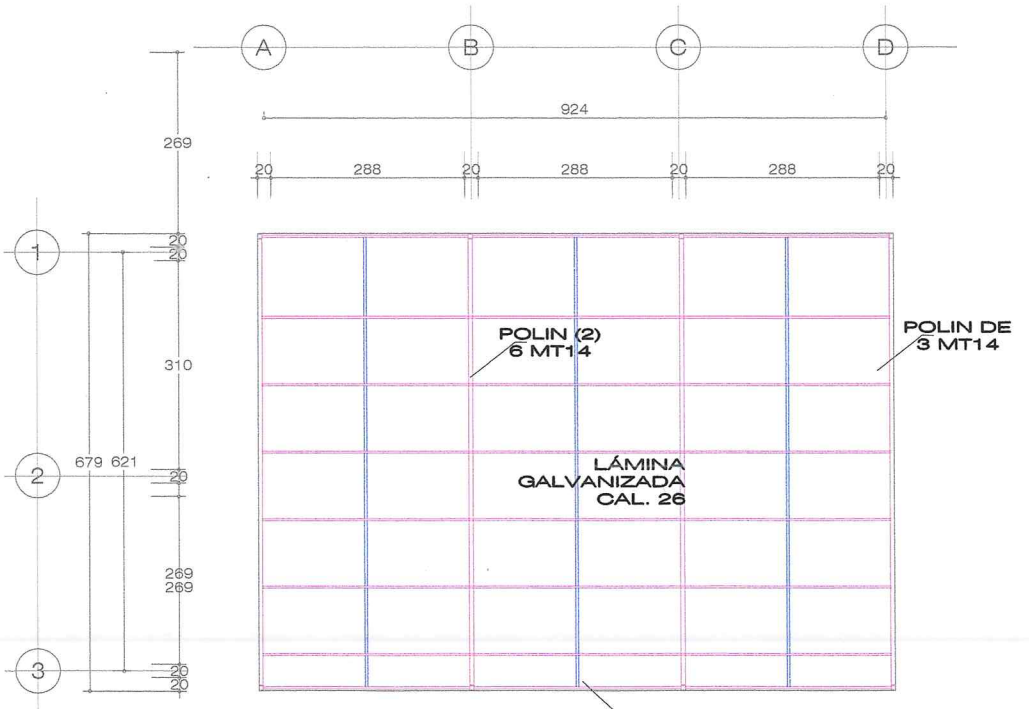

Obra: CONSTRUCCIÓN DE ÁREA DE ALMACEN (BODEGA) DE RESGUARDO DE HERRAMIENTAS Y REFACCIONES EN POLICIA ESTATAL PREVENTIVA	
Localidad: Culiacán	Municipio de: Culiacán
Contenido: ALMACEN PLANO ESTRUCTURAL	
Dibujo: ARQ. MARIA DELGADO LOPEZ	
Escala: 1:100	
Fecha: 03/01/2022	Plano: 02



Simbología

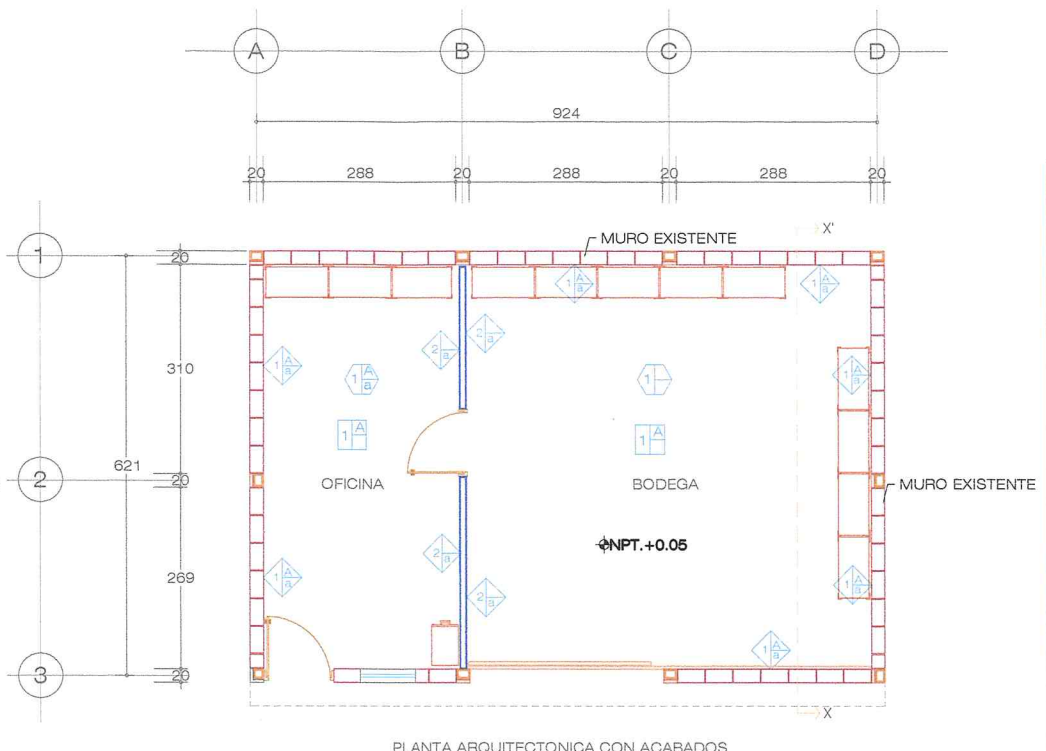
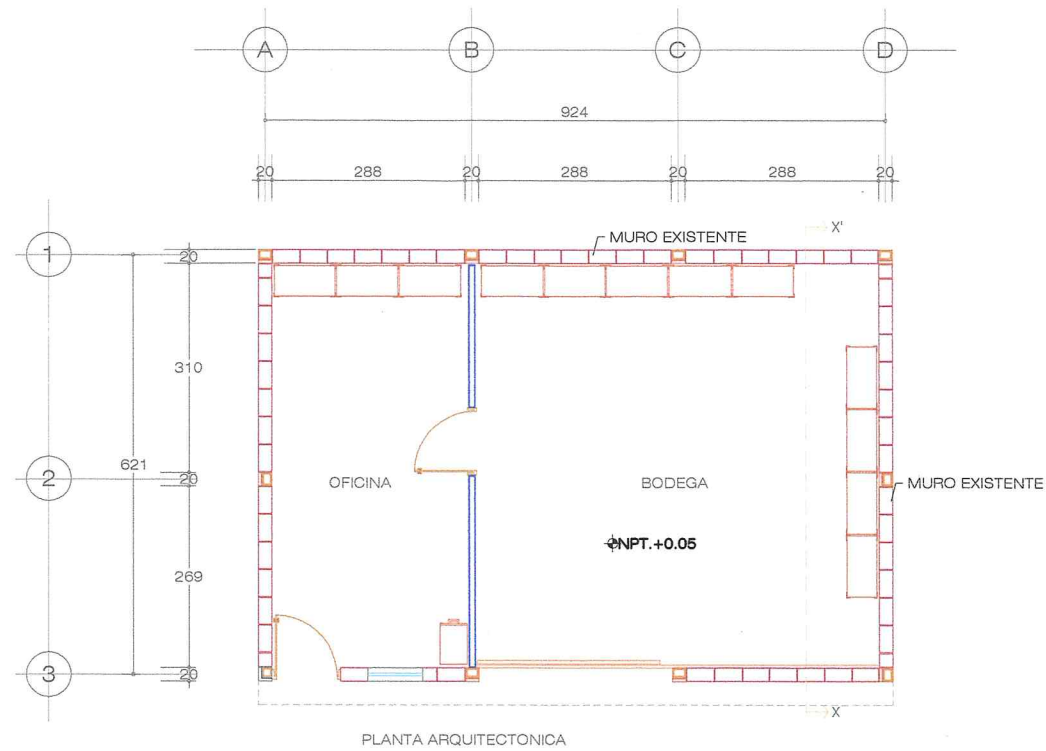

PISOS	Base	Inicial	Final	Cambio de acabado
BASE				
ACABADO INICIAL				
ACABADO FINAL				
MUROS	Base	Inicial	Final	Cambio de acabado
BASE				
ACABADO INICIAL				
ACABADO FINAL				
TECHOS	Base	Inicial	Final	Cambio de acabado
BASE				
ACABADO INICIAL				
ACABADO FINAL				

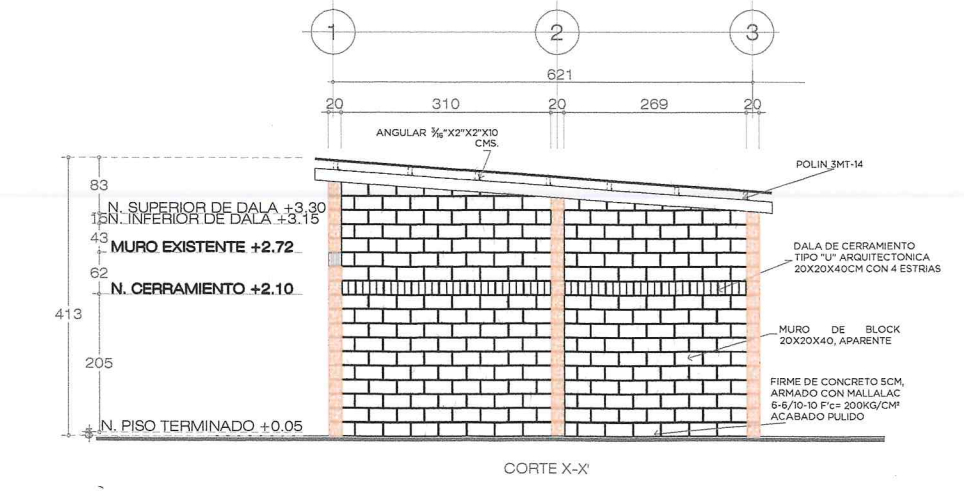
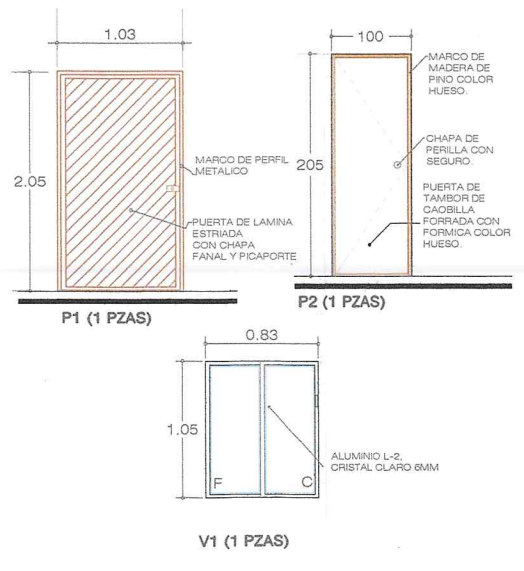
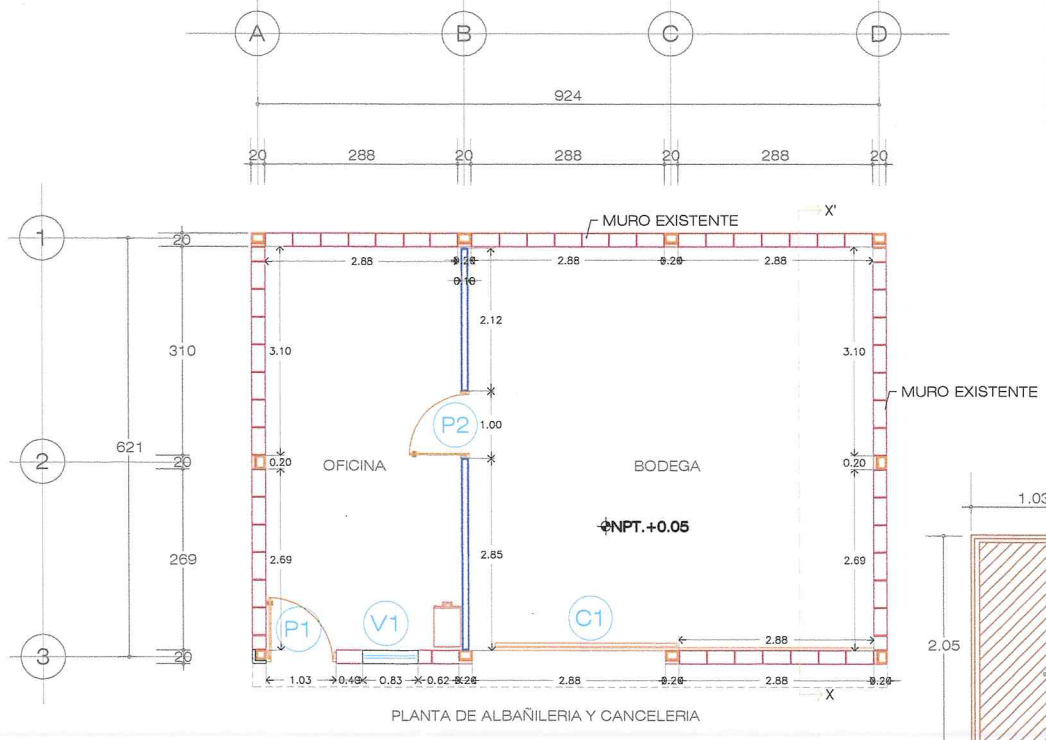

GUIA AL PISO CON 2 ANGULARES DE 1-1/4"X1/2" X 2" CON ANCLAS Ø 3/8" CON JUEGO DE LLANTAS CR9000 SOLDADAS EN LOS EXTREMOS

Obra: CONSTRUCCIÓN DE ÁREA DE ALMACÉN (BODEGA) DE RESGUARDO DE HERRAMIENTAS Y REFACCIONES EN POLICIA ESTATAL PREVENTIVA

Localidad: Culiacán Municipio de: Culiacán

Contenido: **ALMACEN PLANO CONSTRUCTIVO**

Dibujo: ARQ. MARIA DELGADO LOPEZ

Escala: 1:100

Fecha: 03/01/2022 Plano: 01