

ORDENADAS DE LA CURVA MASA	VOLUMEN		ESPESOR		ELEVACION	
	TERRAPLEN	CORTE	TERRAPLEN	CORTE	SUBRASANTE	TERRENO
0+000.000	0.00	0.00	0.00	0.49	12.10	12.59
0+020.000	0.00	100.57	0.00	0.61	11.77	12.37
0+040.000	0.00	94.16	0.00	0.48	11.43	11.92
0+060.000	0.00	85.81	0.00	0.58	11.10	11.68
0+078.061	84.26	84.26	0.53	0.53	10.78	11.23
0+082.561	17.24	17.24	0.87	0.87	10.70	11.37
0+087.061	25.43	25.43	0.78	0.78	10.70	11.48
0+100.000	85.44	85.44	0.88	0.88	11.01	11.89
0+120.000	0.00	113.92	0.50	0.50	11.50	12.00
0+132.076	48.40	48.40	0.48	0.48	11.45	11.93
0+136.576	17.99	17.99	0.53	0.53	11.43	11.96
0+149.898	14.65	14.65	0.55	0.55	11.42	11.89
0+160.000	91.60	91.60	0.60	0.60	11.33	11.93
0+180.000	98.04	98.04	0.57	0.57	11.25	11.82
0+200.000	97.48	97.48	0.60	0.60	11.00	11.60
0+220.000	99.76	99.76	0.60	0.60	10.75	11.35
0+240.000	96.21	96.21	0.56	0.56	10.50	11.06
0+260.000	96.93	96.93	0.59	0.59	10.01	10.60
0+280.000	113.94	113.94	0.78	0.78	9.52	10.30
0+287.006	38.25	38.25	0.51	0.51	9.35	9.86

PERFIL
 ESCALA HORIZONTAL 1 : 1000
 ESCALA VERTICAL 1 : 1000
 TOTAL VOLUMEN CORTE = 1,425.37m³
 TOTAL VOLUMEN TERRAPLEN = 0.00m³

CALLE KINO VIEJO
 ENTRE AV. SANTA CLARA Y FCOS. I. MADERO
 EN COL. COLOSIO SI

- POSTE C.F.E.
- POSTE TELMEX
- POZO DE VISITA
- ⊠ B N ESQUINA DE BANQUETA
- ARBOL
- ANUNCIO
- LUMINARIA
- CASETA TELMEX

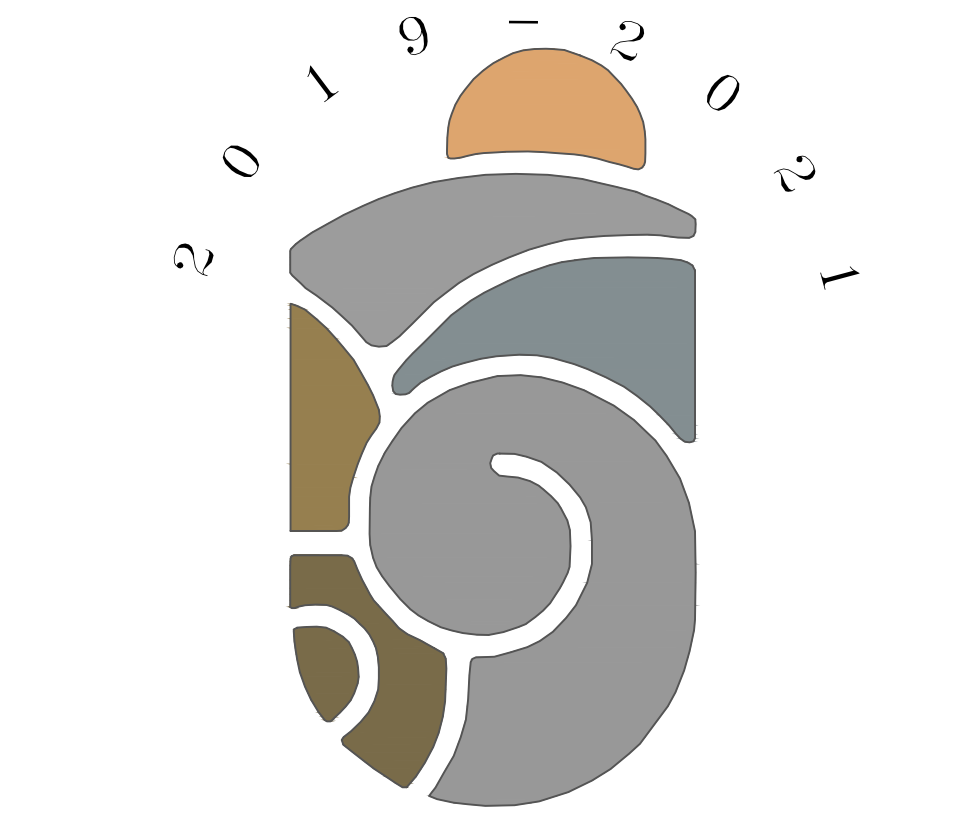
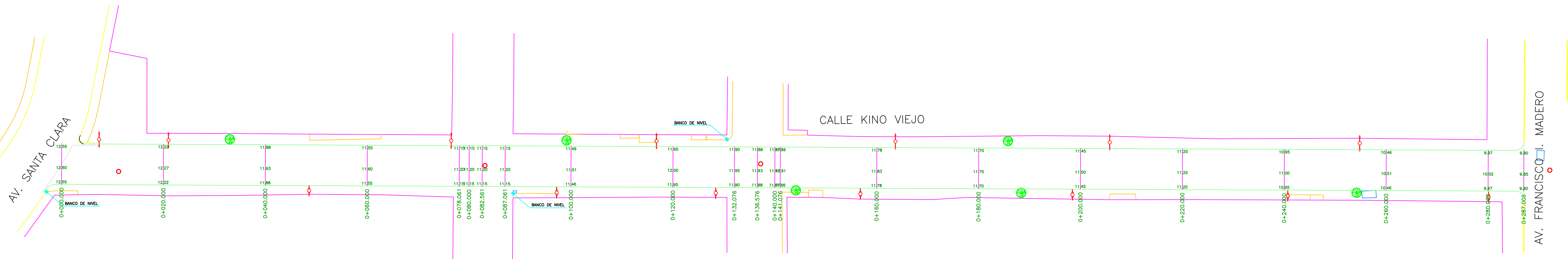
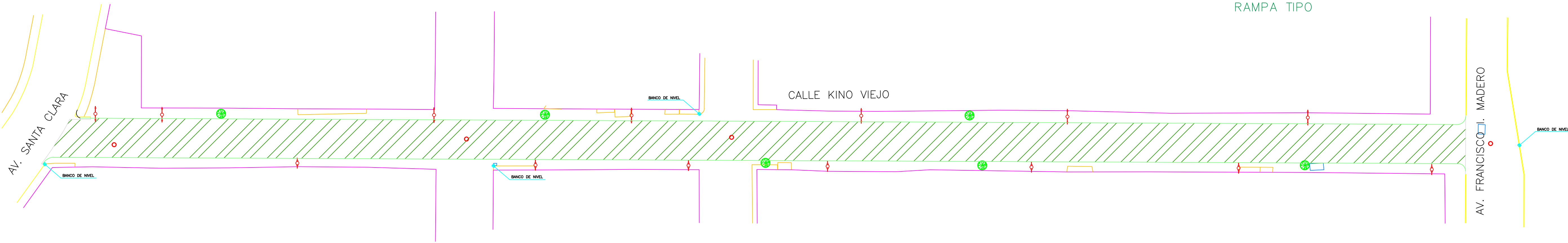
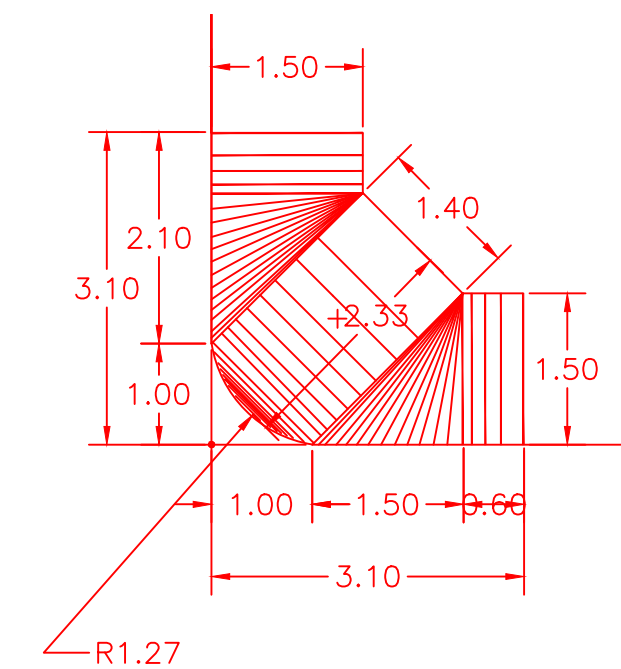
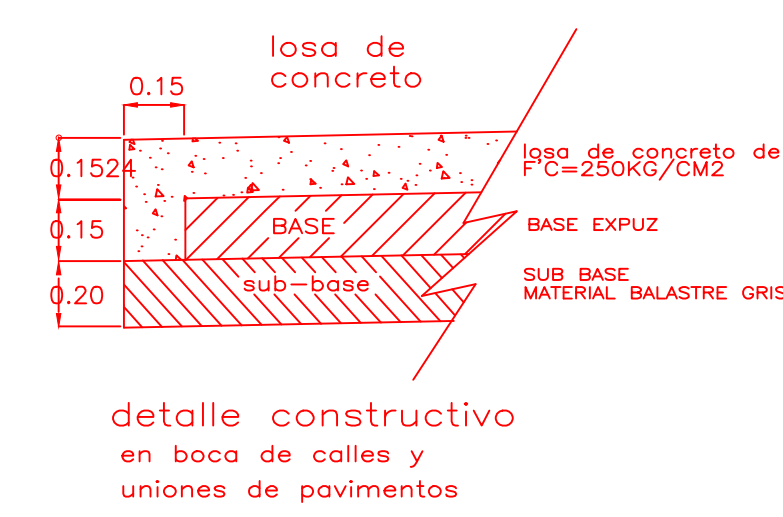
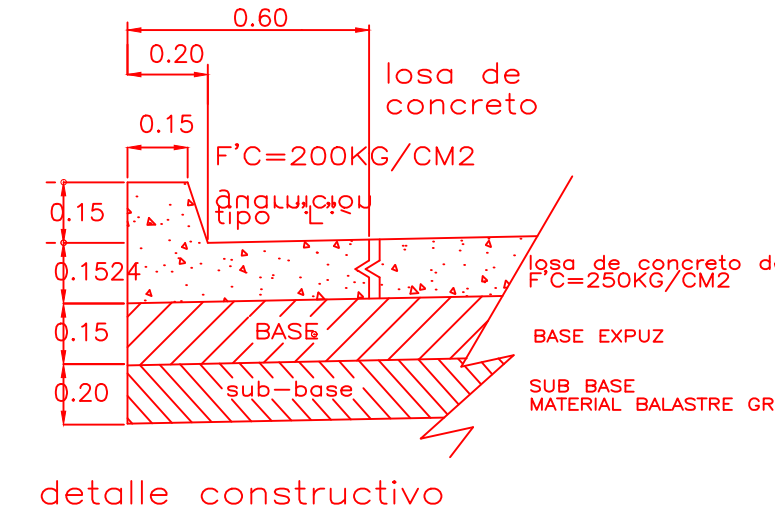

MAZATLÁN
 DONDE SE ROMPEN LAS OLAS

PRESIDENTE MUNICIPAL
QFB. LUIS GUILLERMO BENITEZ TORRES

DIRECTOR DE OBRAS PUBLICAS
M.I. JUAN DE DIOS GARAY VELAZQUEZ

SUBDIRECTOR DE OBRAS PUBLICAS
ARQ. CARLOS JESUS TAPIA CAMACHO

JEFE DEL DEPTO. DE PROYECTO Y TOPOGRAFIA:
ING. JUAN CARLOS GALARZA BARRON

INTEGRANTES DEL DEPARTAMENTO DE PROYECTOS:
 ING. CARLOS MANUEL TAPIA BARRON
 ARQ. PATRICIA ARAUZ CRISTERNA
 ARQ. JESUS IVAN MORENO JIMENEZ

PROYECTO:
 CALLE KINO VIEJO
 ENTRE AV. SANTA CLARA Y FCOS. I. MADERO
 EN COL. COLOSIO SI

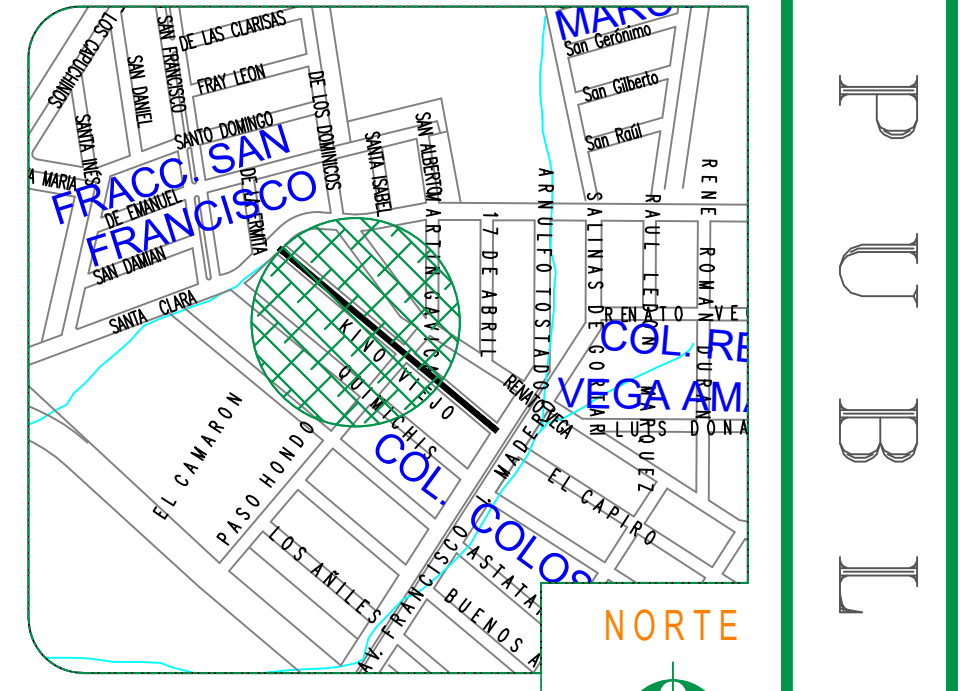

ESCALA: S/E

LAMINA No. **1**

FECHA: **JULIO DEL 2019**

DISEÑO - DIBUJO:
 ING. CARLOS MANUEL TAPIA BARRON
 ARQ. JESUS IVAN MORENO JIMENEZ

CLAVE

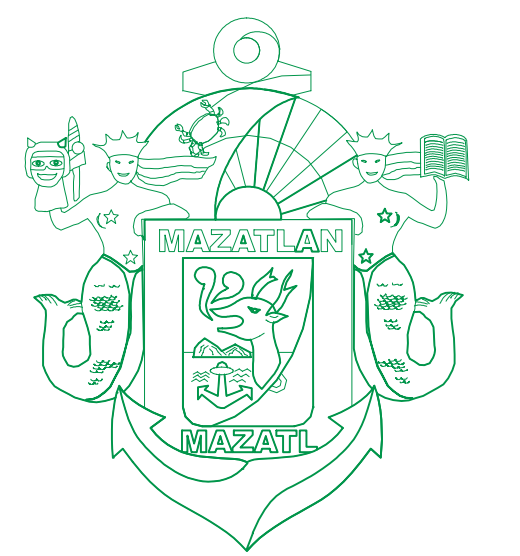

MUNICIPIO DE MAZATLÁN
 CALLE ANGEL FLORES S/N COLONIA CENTRO MAZATLÁN, S.N.

OBRAS PUBLICAS